

ATEX LED HT-400Z0 Headtorch

Zones: 0, 1, 2, 20, 21 and 22



Product Overview

The ATEX LED HT-400Z0 Headtorch is the ideal compact headtorch for hands free lighting, particularly where access is difficult, requiring climbing or crawling and is CE marked to the ATEX Directive and IECEx certified for safe use in Zones 0, 1 and 2 potentially explosive gas and Zones 20, 21 and 22 dust atmospheres. The approval code also covers all group II (industrial) gas apparatus groups, for potentially explosive gases up to T4 temperature class.

The HT-400Z0 is compact and lightweight weighing only 90 grams including batteries and constructed from robust, highly durable, high impact thermoplastic materials which are chemical resistant, and is fitted with a shatterproof polycarbonate lens. The tilt adjustment mechanism allows the user to angle the light and the bespoke optics deliver a broad spot beam suitable for close up hands free tasks, and is designed for single-handed switching and water/dust tight to a minimum of IP67.

With a 'fitted for life' high power LED light source, the HT-400Z0 has up to 75 lumens of light output, with an optimum light duration of approximately 8.5 hours from a set of three AAA alkaline cells. The use of primary cells makes it economical for personal lighting.

The ATEX LED HT-400Z0 Headtorch is supplied fitted with an adjustable removable fabric head band allowing it to be comfortably worn, at a low profile, directly on the head for extended periods and a set of 4 helmet clips to allow it to be securely attached to a hardhat.

Features & Benefits

- ATEX Directive compliant
- IECEx Scheme certified
- Zone 0, 1 & 2 explosive gas, vapour and mist and Zone 20, 21 & 22 dust certified
- T4 temperature class
- High Power LED light source
- Lightweight, ergonomic design
- Single handed switching
- Hands free operation
- IP67 water and dust tight
- Adjustable, removable headband
- Supplied with helmet clips for hard hat use
- Tilt adjustment for light direction

Certifications



0598

Technical Specification

Product Reference		HT-400Z0
Product Description		ATEX LED Headtorch
Code	Industrial	II 1GD Ex ia op is IIC T4 Ga IP67 Ex ia op is IIIB T125° C Da
Type of Protection		'ia' Intrinsic Safety, 'op is' Optical Radiation
Area of Classification (Gas)		Zones 0, 1 and 2, Gas groups IIA, IIB, IIC
Temp. Classification (Gas)		T4
Ambient Temperature		-20° C to +40° C
Area of Classification (Dust)		Zones 20, 21 and 22, Dust groups IIIA, IIIB
Max Surface Temperature (Dust)		125° C
Certificate		Baseefa10ATEX0067X IECEX BAS 10.0023X
Enclosure		High Impact Thermoplastic, Chemical Resistant
Lens		Shatterproof Polycarbonate
Beam Type		Broad Spot with Wide Angle Fringe Light
Light Source:	Type	High Power LED
	Output	Up to 75 lm
	Life	25,000+ hours (fitted for life)
Power Source:	Part Number	3 x LT-401 (LR03 Cells)
	Type	LR03 primary cells, to IEC 60086, Alkaline AAA
	Volts	3 x 1.5v
Light Duration		Up to 8.5 hours
Ingress Protection		IP67
Weight (inc. cells)		0.090Kg

- All information has been gathered under laboratory conditions, the user must regard the values given as approximate.
- Changes may be made to the above specification without notification, details are available on request.

Product Dimensions

Light Output

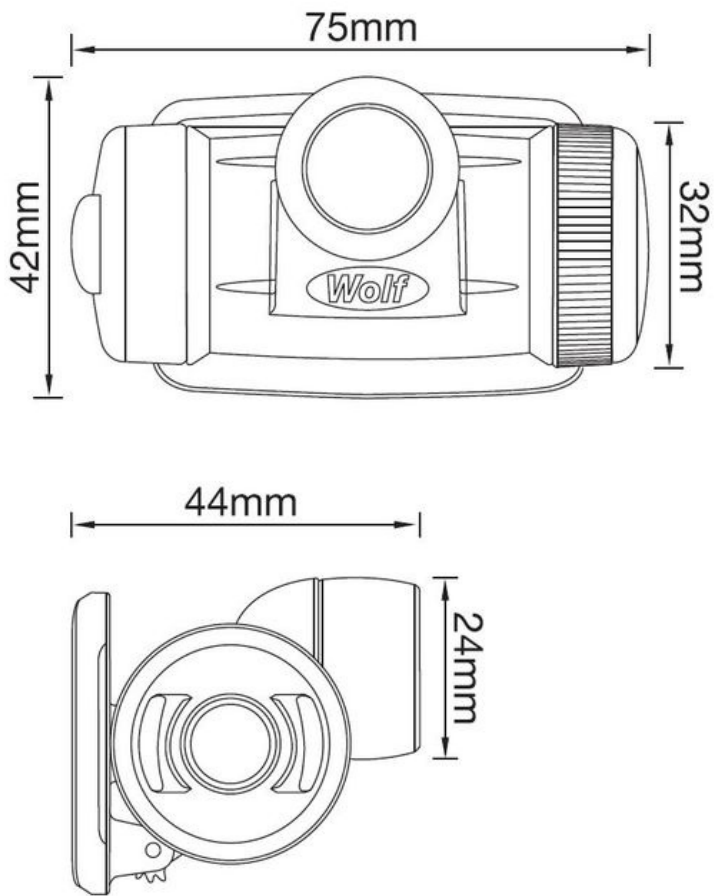

High Power LED spot beam (approx 20°)
 Peak luminous intensity at 1m **381 lux**, at 2.5m **52 lux**
 Extra wide angle fringe beam (approx 85°)
 Peak luminous intensity at 1m **25 lux**, at 2.5m **6 lux**

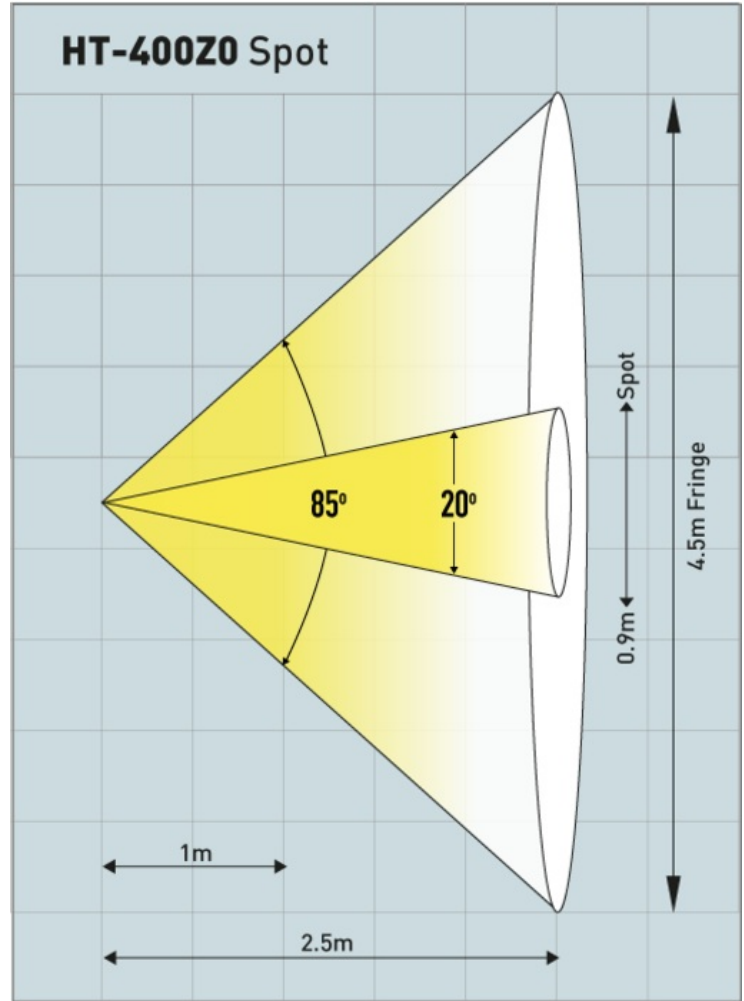

Version: SL086 DF602 Issue 4

Wolf®

Wolf Safety Lamp Company, Saxon Road Works, Sheffield, S8 0YA, UK

- T: +44 (0) 114 255 1051 • F: +44 (0) 114 255 7988
- E: info@wolfsafety.com • www.wolfsafety.com

